

## Kleště s kulatými čelistmi s břitem

(ozdobné ohýbací kleště)

DIN ISO 5743

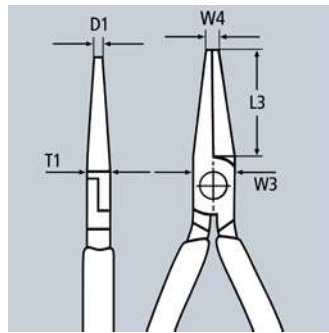





19



- > pro jemné práce s drátem a stříbrnými šperky
- > vhodné pro ohýbání a stříhání např. v oblasti elektroniky
- > k ohýbání drátěných ok
- > jemné, do špičky vybíhající, zakulacené čelisti, precizně broušené
- > břity doplňkově induktivně tvrzené, tvrdost břitů asi 60 HRC
- > vanadová elektroocel, kovaná, kalená v oleji v několika stupních



19 01 130  
8  

| Č. výr.   | EAN<br>4003773- | ↔<br>mm |   | Kleště                             | Hlava   | Rukojeti         | Řezné hodnoty |      | Rozměry  |          |          |          |          | <br>g |
|-----------|-----------------|---------|---|------------------------------------|---------|------------------|---------------|------|----------|----------|----------|----------|----------|--|
|           |                 |         |   |                                    |         |                  | Ø mm          | Ø mm | D1<br>mm | L3<br>mm | T1<br>mm | W3<br>mm | W4<br>mm |  |
| 19 01 130 | 034995          | 130     |   | fosfátováno a tramentolem na černo | leštěno | potaženo plastem | 2,2           | 1,6  | 1,0      | 32,0     | 8,0      | 13,5     | 2,0      | 73   |
| 19 03 130 | 014348          | 130     |   | chromované                         |         | potaženo plastem | 2,2           | 1,6  | 1,0      | 32,0     | 8,0      | 13,5     | 2,0      | 72   |

## Ploché kleště s břitem

(Kleště na jemnou mechaniku)

DIN ISO 5745



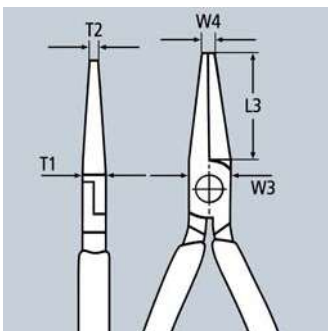



23



- > vhodné pro uchopování a stříhání v jemné mechanice
- > ploché, dlouhé čelisti v tenkém provedení
- > břity doplňkově induktivně tvrzené, tvrdost břitů asi 60 HRC
- > speciální nástrojová ocel ve zvláštní jakosti, kovaná, kalená v oleji v několika stupních



23 01 140  
  

| Č. výr.   | EAN<br>4003773- | ↔<br>mm |    | Hlava   | Rukojeti         | Řezné hodnoty |      | Rozměry  |          |          |          |          | <br>g |
|-----------|-----------------|---------|---|---------|------------------|---------------|------|----------|----------|----------|----------|----------|--|
|           |                 |         |   |         |                  | Ø mm          | Ø mm | T1<br>mm | L3<br>mm | W3<br>mm | W4<br>mm | T2<br>mm |  |
| 23 01 140 | 041290          | 140     |    | leštěno | potaženo plastem | 2,5           | 1,6  | 7,0      | 35,0     | 12,5     | 3,0      | 4,5      | 75   |

## Kleště s půlkulatými čelistmi a středovým břitem

(Kleště pro telefonní spoje)

DIN ISO 5743



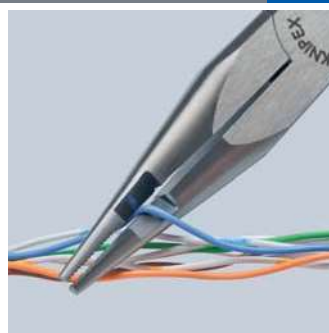
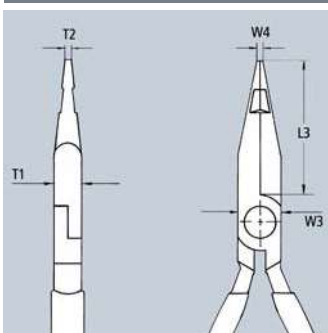



27



- > k uchopování a stříhání jednotlivých vodičů v kabelových svazcích
- > se štípacími kleštěmi se středovými břity pro měkký drát
- > půlkulaté čelisti
- > plochy čelistí ozubené
- > chromvanadová elektroocel, kovaná, kalená v oleji



27 01 160  
  

| Č. výr.   | EAN<br>4003773- | ↔<br>mm |    | Hlava   | Rukojeti         | Rozměry  |          |          |          |          | <br>g |
|-----------|-----------------|---------|---|---------|------------------|----------|----------|----------|----------|----------|--|
|           |                 |         |   |         |                  | L3<br>mm | W3<br>mm | T1<br>mm | W4<br>mm | T2<br>mm |  |
| 27 01 160 | 016106          | 160     |    | leštěno | potaženo plastem | 47,0     | 16,5     | 9,5      | 3,0      | 2,0      | 120  |